



Digitized Automation for a Changing World

Delta Basic Compact Drive ME300 Series



www.deltaww.com

 **DELTA**
Smarter. Greener. Together.

Compact and Intelligent

The new standard for micro drives

The automation industry today is facing challenges such as increasing competition and rising costs. In addition to improving productivity and reducing direct labor, the driving force for automation is to achieve higher efficiency, optimal quality, and most importantly, flexibility and compatibility for a wide range of applications.

Delta's ME300 series is the new generation compact vector control drive that inherits Delta's superior drive technology with 60% volume reduction. Various essential functions are built-in as standard, including: user-defined parameter groups, single and multi-pump functions, built-in brake chopper and EMC filter (C2 Class). It reduces the need for additional expense and provides more installation space in the control cabinet. The ME300 also supports both induction and interior/surface permanent motors, providing more efficiency and flexibility. The STO function ensures smooth operation while protecting facilities from damage, and the new screw-less wiring design of terminal blocks offers a simplified wiring process for quick installation.

User-friendly operation, ultra-compact size, quick installation, and flexible, durable design provide the user with a highly efficient and stable system. The ME300 is your key to increased market competitiveness that leads to your success.





Models Overview

Hardware Design
Side-by-side Installation
Standard Models



Outstanding Drive Performance

Supports IM and PM Motors
High Starting Torque
Deceleration Energy Backup (DEB)
Enhanced Braking Capability



Strong System Support

Pump Control
Multi-pump Control
Pulse Input
Built-in Modbus Communication
Built-in Braking Chopper
High Overload Capability
Common DC Bus



Stable, Safe and Reliable

Safe Torque Off
PCB Coating
NEMA1 Kit (Optional)
Built-in EMC Filter



Easy Set Up

Application Groups (Macro)
Screwless Wiring of Control Terminal



Wide Range of Applications

Single / Multi-pumps
Conveyors
Fans
Woodworking Machines
Packaging Machines
Textile Machines



Specifications

Product Specifications
General Specifications and Accessories
Operating Environment
Wiring
Dimensions
Accessories
Model Name
Ordering Information

Models Overview

Hardware Design

Compact design and user-friendly interface

Size reduction *
60%

An orange callout box with a white background contains the text 'Size reduction *' and '60%'. An orange arrow points from this box to a smaller, more compact version of the Delta ME300 VFD, which is shown next to the larger standard model for comparison.

User-friendly Control and Display

4 digit LED display, frequency setting potentiometer, direction function keys

A close-up image of the control panel. It features a red 4-digit LED display showing 'F500'. Below the display is a black rotary potentiometer for frequency setting. There are several push buttons: a green 'RUN' button, a red 'STOP/RESET' button, a blue 'MODE' button, and a blue 'ENTER' button. There are also two arrow buttons for navigation.

Removable Fan

Easy to replace and maintain for a longer lifetime

A close-up image of the fan assembly, showing a black fan housing with a green LED indicator light.

Removable RF Jumper

Applicable for different application needs

A close-up image of the RF jumper mechanism, showing a metal tab that can be moved to different positions to adjust the radio frequency.



Screwless Front Case

Press on both side tabs to remove the case

A close-up image of the front case mechanism, showing two side tabs that can be pressed to remove the case without the need for screws.

*Up to 60% size reduction compared with corresponding ratings of Delta's VFD-EL Series

Side-by-Side Installation

Flexible and efficient installation supports side-by-side installation with operating temperature of -20°C ~ 40°C

*standalone installation: 50°C without load dropping.
Max. ambient temperature is 60°C.

Substantial space savings!



Standard Models

115V single-phase

Applicable Motor Output (kW)	0.1	0.2	0.4	0.75
Applicable Motor Output (HP)	0.125	0.25	0.5	1
Frame Size	A		C	

230V single-phase

Applicable Motor Output (kW)	0.1	0.2	0.4	0.75	1.5	2.2
Applicable Motor Output (HP)	0.125	0.25	0.5	1	2	3
Frame Size	A			B	C	

230V single-phase (Built-in EMC filter)

Applicable Motor Output (kW)	0.1	0.2	0.4	0.75	1.5	2.2
Applicable Motor Output (HP)	0.125	0.25	0.5	1	2	3
Frame Size	B				C	

230V 3-phase

Applicable Motor Output (kW)	0.1	0.2	0.4	0.75	1.5	2.2	3.7/4	5.5
Applicable Motor Output (HP)	0.125	0.25	0.5	1	2	3	5	7.5
Frame Size	A				B	C		D

460V 3-phase

Applicable Motor Output (kW)	0.4	0.75	1.5	2.2	3	3.7/4	5.5	7.5
Applicable Motor Output (HP)	0.5	1	2	3	4	5	7.5	10
Frame Size	A		B	C			D	

460V 3-phase (Built-in EMC filter)

Applicable Motor Output (kW)	0.4	0.75	1.5	2.2	3	3.7/4	5.5	7.5
Applicable Motor Output (HP)	0.5	1	2	3	4	5	7.5	10
Frame Size	B			C			D	

Outstanding Drive Performance

Supports IM and PM Motors

Supports 2 independent induction motor control parameter sets

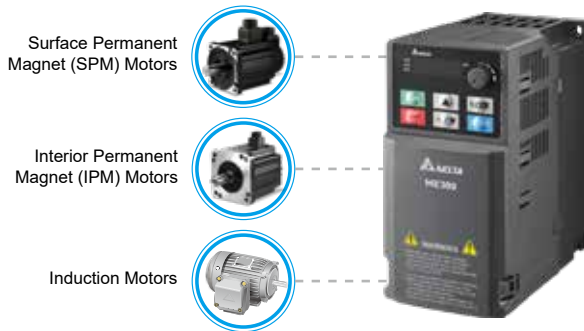

High Starting Torque

Delivers 200% high starting torque with a low speed control of 3Hz. This feature provides outstanding machine stability and is suitable for dynamic loading applications

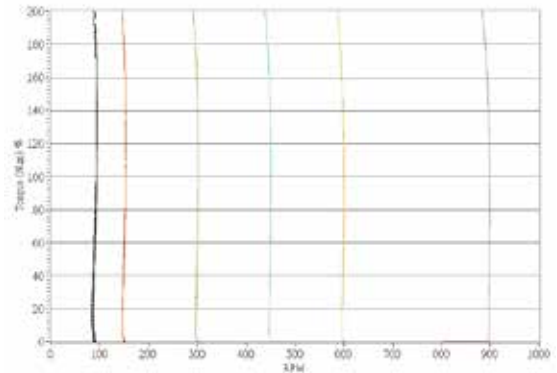

Deceleration Energy Backup (DEB)

Controls the motor deceleration to a stop when an unexpected power shut-down occurs to prevent mechanical damage. When power resumes, the motor will accelerate to its previous speed

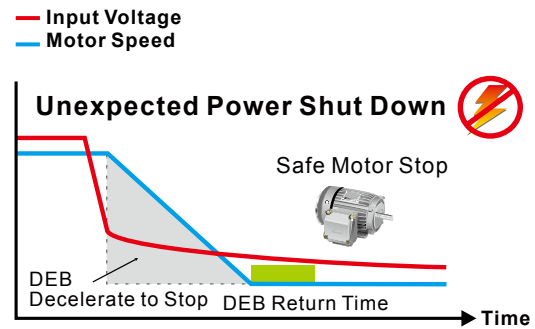
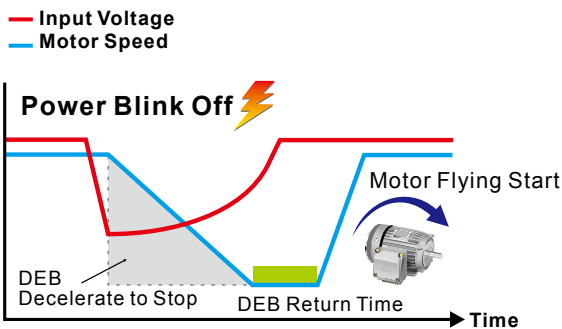

Enhanced Braking Capability

The Deceleration Energy Control Mode shortens braking time by adjusting the motor speed and current, and replaces the need for braking resistors

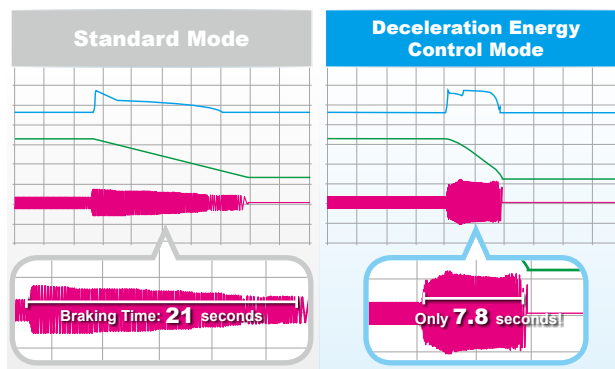

* Actual deceleration performance varies upon different system loads

Strong System Support

Pump Control

- Sleep Mode & Leakage Detection: When the system is at constant pressure, the ME300 will enter / stay in sleep mode to prevent frequent starting and stopping (Proper parameter settings required)
- Dry-run Detection: When the water supply is off, the ME300 will decelerate to stop to protect pump from dry-runs

Multi-pump Control

- Alternate Operation: Alternates pump operation in cycles. Cycle can be set by hours, days or weeks
- Constant Pressure Mode: Provides consistent energy-efficient water supply by adjusting operating pump quantities based on real-time demands

ME300 Status o Operating s Standby

Alternate Operation

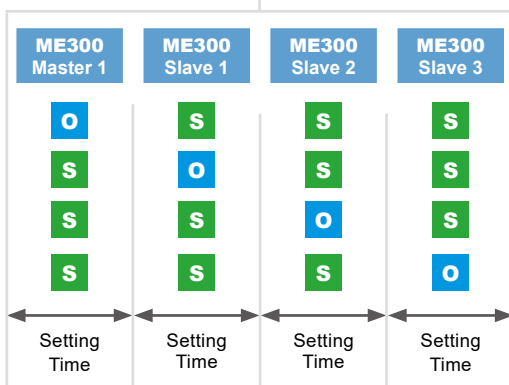

Constant Pressure Mode



Pulse Input

Supports single pulse and PWM input (10 kHz) from controller as frequency command

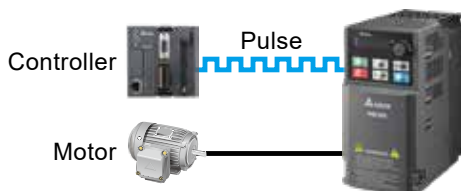

High Overload Capability

- Normal duty: rated current 120% for 60 seconds; 150% for 3 seconds
- Heavy duty: rated current 150% for 60 seconds; 200% for 3 seconds

Built-in Modbus Communication

Built-in RS-485 (Modbus) communication

Built-in Braking Chopper

Larger braking torque capability with an additional braking resistor

Common DC Bus

DC ± terminals for common DC bus wiring; the drives share the regeneration power during deceleration to save energy and the braking resistor

Stable, Safe and Reliable

Safe Torque Off

Compliant with:

- ▶ ISO 13849-1:2015 Category 3 PL d
- ▶ EN 61508 SIL2

- ▶ EN 60204-1 Category 0
- ▶ EN 62061 SIL CL 2

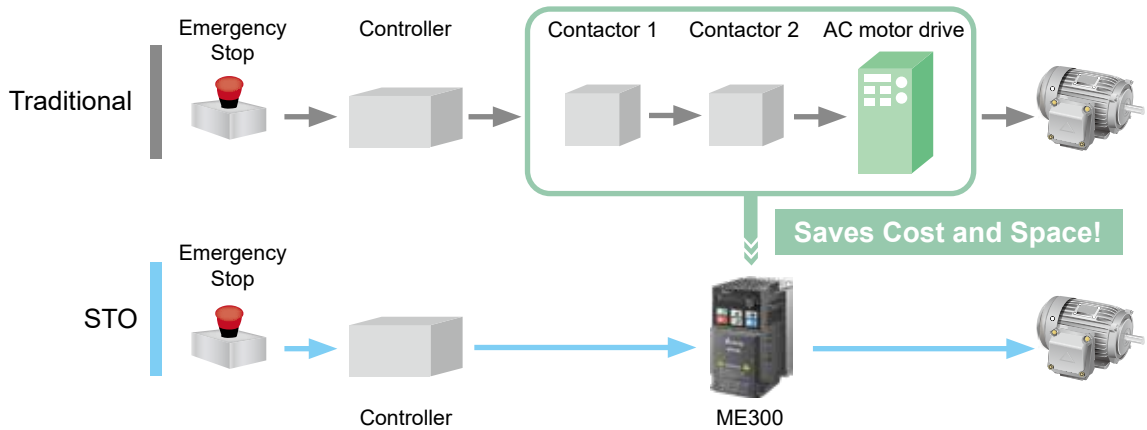

PCB Coating

100% PCB coating (IEC 60721-3-3 class 3C2 standard) ensures drive operation stability and safety in critical environments

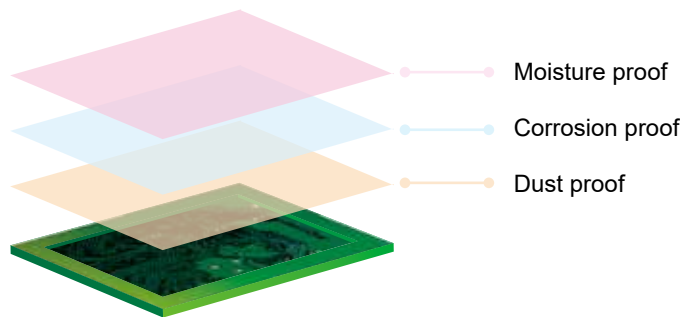

NEMA 1 Kit (Optional)

Provides NEMA 1 kit to prevent dust and other particles from entering the drive and avoids risk from electric shock. It is suitable for applications under critical conditions



Built-in EMC Filter

Built-in Class A (C2)* standard EMC filter saves additional procurement cost and wiring time, and provides more cabinet space for other devices to use

*Class A (C3) for 400V models

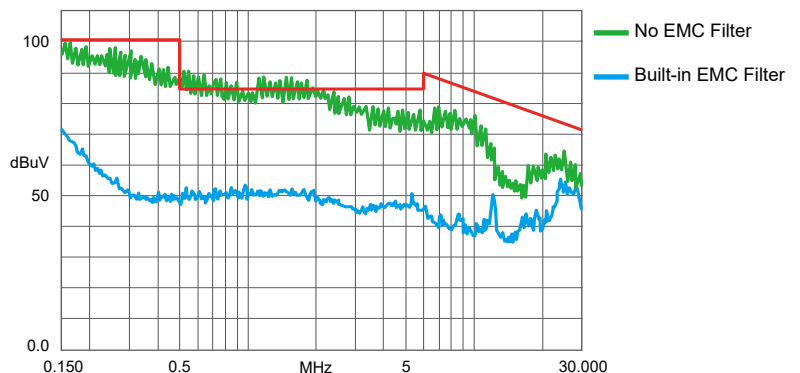

Easy Set Up

Application Groups (Macro)

- Simplifies the parameter setting process by grouping the parameters for different applications to use
- Users can establish own parameter group for different customers or equipment
- User-defined parameter values can be retained when resetting to default

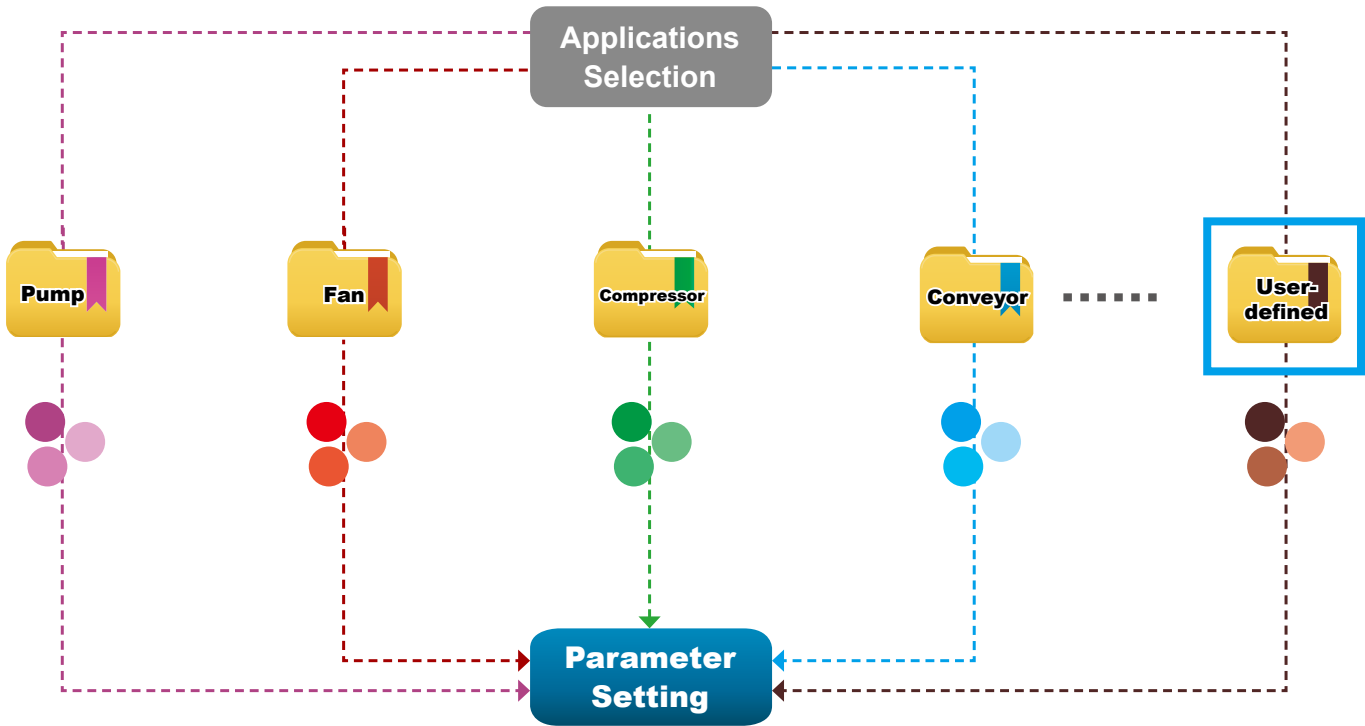

Screwless Wiring of Control Terminal

Spring clamp terminal blocks provide fast and easy wiring

Saves wiring time

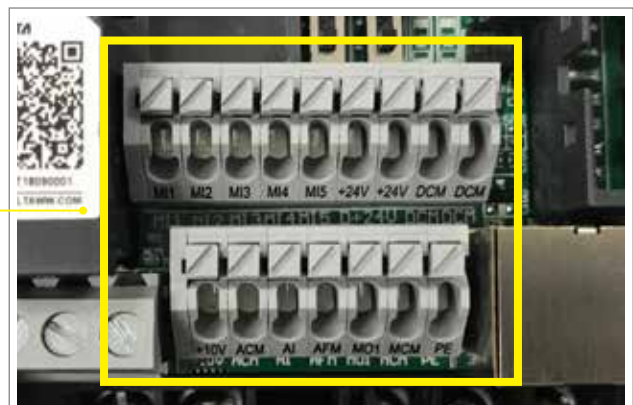

Wide Range of Applications

Single / Multi-pumps

- Built-in PID feedback control, no additional PID controller required
- Supports multi-pumps (constant pressure) and alternate operation
- Equipped with liquid leakage detection function and sleep mode
- Displays actual and target value at the same time for easy operation
- Pump or self-defined parameter groups for easy setting
- Wide range voltage input for various types of pumps and areas

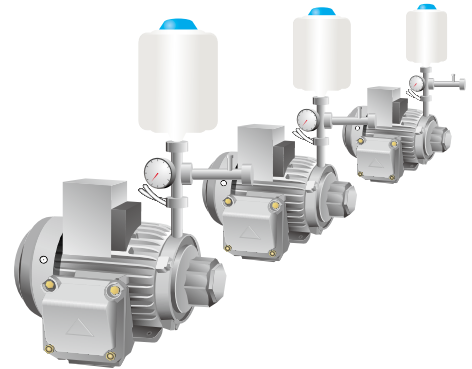

Conveyors

- Built-in potentiometer for easy adjustment
- High starting torque: up to 200% at 0.5 Hz
- Outstanding acceleration / deceleration performance improves production efficiency
- Built-in braking chopper saves space and purchasing costs
- 2 sets of motor parameters for more flexibility
- Compact design for space savings
- STO function enhances system safety



Fans

- Supports both induction motor and permanent motor (IPM/SPM)
- Supports multi-pole motors for low speed operation
- Built-in potentiometer for easy adjustment
- Speed search function allows motor start without stopping
- Optimized hardware layout and anti-pollution design resist dust and fiber
- Compact design for space savings

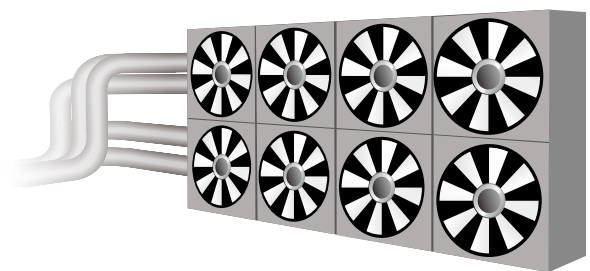

Woodworking Machines

- Outstanding acceleration / deceleration performance improves production efficiency
- STO function enhances system safety
- Built-in EMC filter effectively reduces electromagnetic interference
- Compact in size and weight, easy to install and maintain

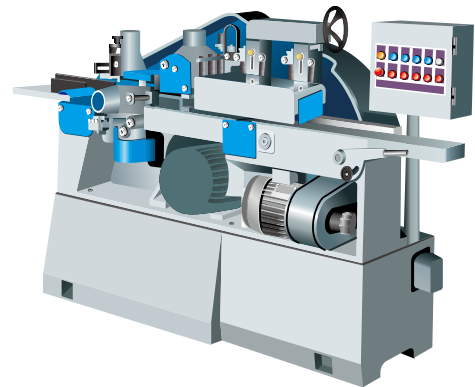

Packaging Machines

- Compact design provides more cabinet space
- STO function enhances system safety
- Built-in braking chopper saves system construction cost
- Built-in RS-485 (Modbus)
- Supports high speed pulse and PWM input as frequency command to improve control precision



Textile Machines

- Optional NEMA1 kit provides excellent protection in environment with dust, fiber and moisture
- Improved heatsink design prevents fiber clogging the air way; modular design of fan is easy to clean and provides longer lifetime
- Improved braking capability shortens the deceleration to stop time, suitable for sudden stop requirements
- Deceleration to stop function protects the equipment from damage when sudden power failure occurs
- STO function enhances system safety
- Supports both induction motors and permanent motors (IPM/SPM)



Specifications

Product Specifications

Single-phase
115V

Models without built-in EMC filter

Frame			A			C
Model VFD□□□ME11			0A8	1A6	2A5	4A8
Applicable Motor Output (kW)			0.1	0.2	0.4	0.75
Applicable Motor Output (HP)			1/8	1/4	1/2	1
Inverter Output	Heavy Duty	Rated Output Current (A)	0.8	1.6	2.5	4.8
	Normal Duty	Rated Output Current (A)	1.0	1.8	2.7	5.5
Input Voltage / Frequency			Single-phase AC, 100V~120V (-15% ~ + 10%), 50 / 60Hz			
Carrier Frequency (kHz)			2 ~ 15 (Default 4)			
Brake Chopper			Built-in			
Cooling Method			Natural air cooling			Fan cooling
Size: W × H (mm)			68 × 128			87 × 157
Size: D (mm)			78	107	136	
Net Weight (kg)			0.4	0.5	1	

Single-phase
230V

Models with built-in EMC filter

Frame			B				C	
Model VFD□□□ME21			0A8	1A6	2A8	4A8	7A5	11A
Applicable Motor Output (kW)			0.1	0.2	0.4	0.75	1.5	2.2
Applicable Motor Output (HP)			1/8	1/4	1/2	1	2	3
Inverter Output	Heavy Duty	Rated Output Current (A)	0.8	1.6	2.8	4.8	7.5	11
	Normal Duty	Rated Output Current (A)	1.0	1.8	3.2	5	8.5	12.5
Input Voltage / Frequency			Single-phase AC, 200V~240V (-15% ~ + 10%), 50 / 60Hz					
Carrier Frequency (kHz)			2 ~ 15 (Default 4)					
Brake Chopper			Built-in					
Cooling Method			Natural air cooling			Fan cooling		
Size: W x H (mm)			72 x 142				87 x 157	
Size: D (mm)			143				163	
Net Weight (kg)			0.4	0.5	0.8	1		

Models without built-in EMC filter

Frame		A		B	C	
Cooling Method		Natural air cooling			Fan cooling	
Size: W × H (mm)		68 × 128		72 × 142	87 × 157	
Size: D (mm)		78	107	127	136	
Net Weight (kg)		0.9			1.5	

Three-phase
230 V

Models without built-in EMC filter										
Frame			A				B	C		D
Model VFD□□□23			0A8	1A6	2A8	4A8	7A5	11A	17A	25A
Applicable Motor Output (kW)			0.1	0.2	0.4	0.75	1.5	2.2	3.7/4	5.5
Applicable Motor Output (HP)			1/8	1/4	1/2	1	2	3	5	7.5
Inverter Output	Heavy Duty	Rated Output Current (A)	0.8	1.6	2.8	4.8	7.5	11	17	25
	Normal Duty	Rated Output Current (A)	1.0	1.8	3.2	5.0	8.0	12.5	19.5	27
Input Voltage / Frequency			Three-phase AC, 200V~240V (-15% ~ + 10%), 50 / 60Hz							
Carrier Frequency (kHz)			2 ~ 15 (Default 4)							
Brake Chopper			Built-in							
Cooling Method			Natural air cooling				Fan cooling			
Size: W × H (mm)			68 × 128				72 × 142	87 × 157		
Size: D (mm)			78	92	125	127	136		138	
Net Weight (kg)			0.4	0.5	0.6	0.8	1		2	

Three-phase
460 V

Models with built-in EMC filter										
Frame			B			C		D		
Model VFD□□□ME43			1A5	2A7	4A2	5A5	7A3	9A0	13A	17A
Applicable Motor Output (kW)			0.4	0.75	1.5	2.2	3	3.7/4	5.5	7.5
Applicable Motor Output (HP)			1/2	1	2	3	4	5	7.5	10
Inverter Output	Heavy Duty	Rated Output Current (A)	1.5	2.7	4.2	5.5	7.3	9	13	17
	Normal Duty	Rated Output Current (A)	1.8	3	4.6	6.5	8	10.5	15.7	20.5
Input Voltage / Frequency			Three-phase AC, 380V~480V (-15% ~ + 10%), 50 / 60Hz							
Carrier Frequency (kHz)			2 ~ 15 (Default 4)							
Brake Chopper			Built-in							
Cooling Method			Fan cooling							
Size: W × H (mm)			72 × 142			87 × 157		109 × 207		
Size: D (mm)			143			163		171		
Net Weight (kg)			0.6	0.7	0.8	1		2		
Models without built-in EMC filter										
Frame			A		B	C		D		
Cooling Method			Natural air cooling			Fan cooling				
Size: W×H (mm)			68 × 128		72 × 142	87 × 157		109 × 207		
Size: D (mm)			113	127	127	136		138		
Net Weight (kg)			0.9			1.5		2.7		

Specifications

General Specifications and Accessories

Control Functions	Control Methods	V/F, SVC
	Applicant Motors	Induction motor (IM), interior permanent magnet (IPM) motor, surface permanent magnet (SPM) motor
	Max. Output Frequency	0.00 ~ 599.00 Hz ($\pm 0.1\%$)
	Starting Torque*	150%/3 Hz (V/f, SVC control for IM, heavy duty) 100%/(1/20 of motor rated frequency) (SVC control for PM, heavy duty)
	Speed Control Range*	1 : 50 (V/f, SVC control for IM, heavy duty) 1 : 20 (SVC control for PM, heavy duty)
	Overload Tolerance	Normal Duty (ND): 120% of rated output current for 60 seconds; 150% of rated output current for 3 seconds Heavy Duty (HD): 150% of rated output current for 60 seconds; 200% of rated output current for 3 seconds
	Frequency Setting Signal	0 ~ 10V / 4(0) 20mA, 1pulse input (10kHz)
	Main Control Functions	Multiple motor switches (2 independent motor parameter settings), fast run, deceleration energy back (DEB) function, fast deceleration function, selectable master and auxiliary frequency source, momentary power loss ride through, speed search, over-torque detection, 16-step speed (max.), accel. / decel. time switch, S-curve accel/decel, 3-wire sequence, JOG frequency, upper/lower limits for frequency reference, DC injection braking at start and stop, PID control, simple positioning function, Modbus integrated as standard
Protection Functions	Motor Protection	Overcurrent protection, overvoltage protection, overload protection, over-temperature protection, phase failure protection
	Stall Prevention	During acceleration, deceleration and running independently
Certifications		UL, CE, RoHS, RCM, TUV, REACH, KC

*Control accuracy may vary depending on the environment, application conditions, or motor types. For details, please contact our company or your local distributor

Operating Environment

Operating Environment	Installation Location	IEC60364-1/IEC60664-1 Pollution degree 2, Indoor use only		
	Ambient Temperature	Operation	IP20/UL Open Type	-20 ~ 50 °C -20 ~ 60 °C (derating required)
			NEMA 1/UL Type 1	-20 ~ 40 °C
		Storage	Zero stacking installation	-20 ~ 50 °C (derating required)
				-40 ~ 85 °C
	Transportation		-20 ~ 70 °C	
		Rated Humidity	Operation	Max. 90%
	Storage/Transportation		Max. 95%	
	Air Pressure	Operation	86 ~ 106 kPa	
		Storage/Transportation	70 ~ 106 kPa	
Pollution Level	Compliant to IEC60721-3-3, 3C2			
Altitude	An altitude of 0 ~ 1000 m for normal operation (derating is required for installation at an altitude above 1000 m)			
Vibration		Compliant to IEC 60068-2-6		
Shock		Compliant to IEC/EN 60068-2-27		

* Please refer to ME300 user manual for more details

Wiring

Input: Single-phase / 3-phase power

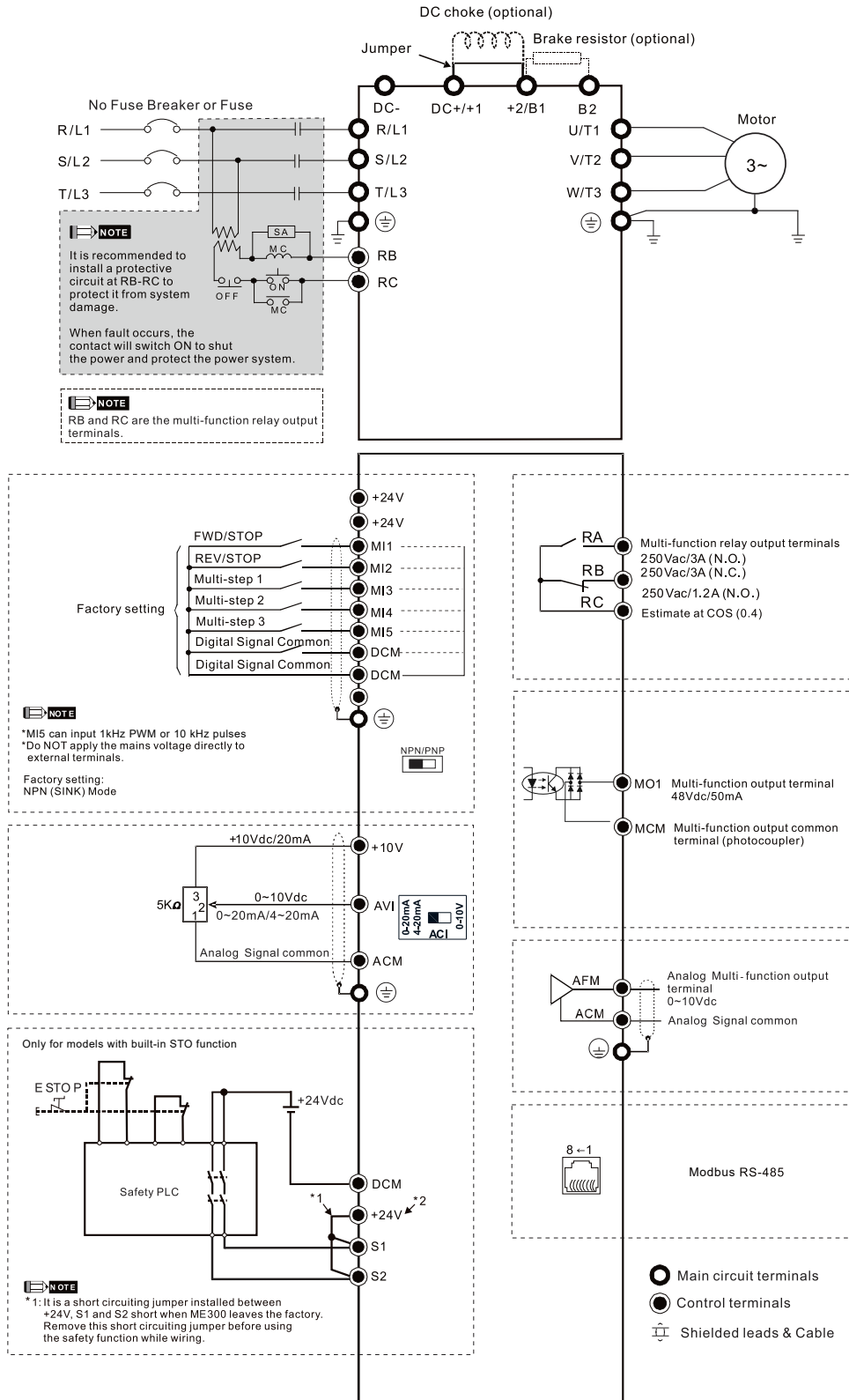

Specifications

Dimensions

Frame A

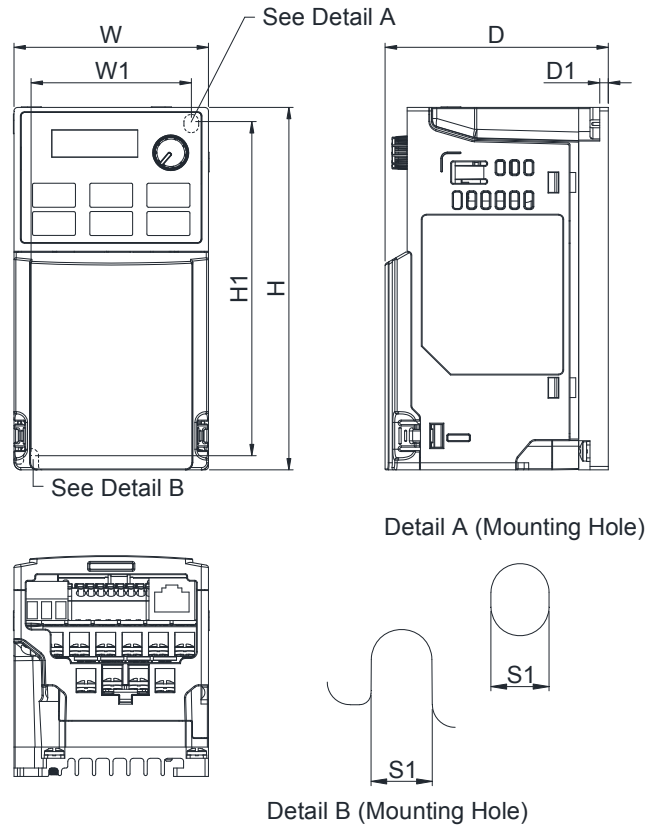

Model	Frame A1	Frame A2	Frame A3	Frame A4	Frame A5	Frame A6
VFD0A8ME11ANNA	VFD2A8ME23ANNA	VFD2A5ME11ANNA	VFD1A5ME43ANNA	VFD4A8ME23ANNA	VFD2A7ME43ANNA	
VFD0A8ME11ANSAA	VFD2A8ME23ANSAA	VFD2A5ME11ANSAA	VFD1A5ME43ANSAA	VFD4A8ME23ANSAA	VFD2A7ME43ANSAA	
VFD0A8ME21ANNA		VFD2A8ME21ANNA				
VFD0A8ME21ANSAA		VFD2A8ME21ANSAA				
VFD0A8ME23ANNA						
VFD0A8ME23ANSAA						
VFD1A6ME11ANNA						
VFD1A6ME11ANSAA						
VFD1A6ME21ANNA						
VFD1A6ME21ANSAA						
VFD1A6ME23ANNA						
VFD1A6ME23ANSAA						

Frame	W	H	D	W1	H1	D1	S1
A1	mm	68.0	128.0	78.0	56.0	118.0	3.0
	inch	2.68	5.04	3.07	2.20	4.65	0.12
A2	mm	68.0	128.0	92.0	56.0	118.0	3.0
	inch	2.68	5.04	3.62	2.20	4.65	0.12
A3	mm	68.0	128.0	107.0	56.0	118.0	3.0
	inch	2.68	5.04	4.21	2.20	4.65	0.12

Frame	W	H	D	W1	H1	D1	S1
A4	mm	68.0	128.0	113.0	56.0	118.0	3.0
	inch	2.68	5.04	4.45	2.20	4.65	0.12
A5	mm	68.0	128.0	125.0	56.0	118.0	3.0
	inch	2.68	5.04	4.92	2.20	4.65	0.12
A6	mm	68.0	128.0	127.0	56.0	118.0	3.0
	inch	2.68	5.04	5.00	2.20	4.65	0.12

Frame B

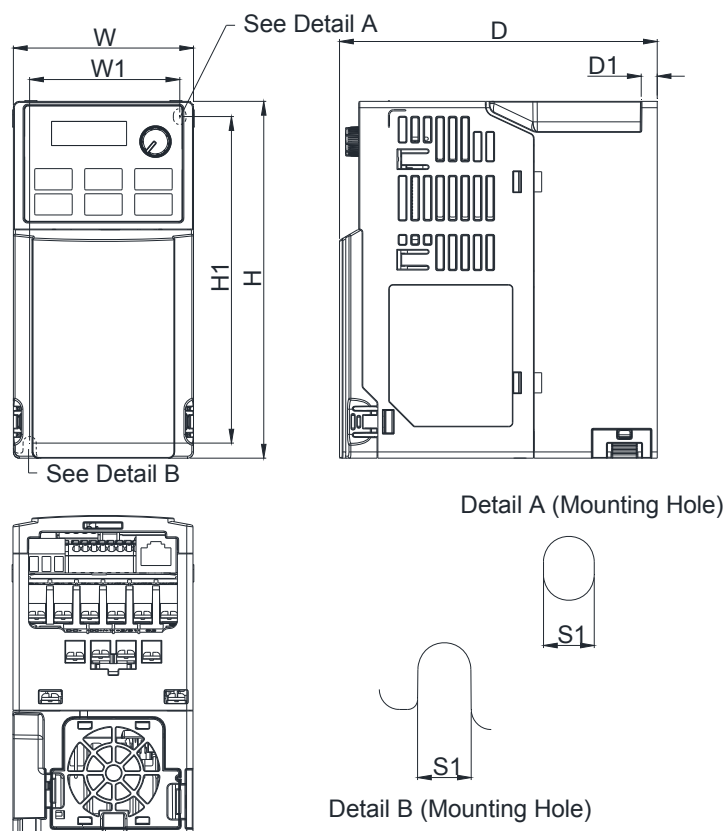

Model	Frame B1	Frame B2	Frame B3	
VFD7A5ME23ANNAA	VFD4A8ME21ANNAA	VFD0A8ME21AFNAA	VFD4A2ME43AFNAA	
VFD7A5ME23ANSAA	VFD4A8ME21ANSAA	VFD0A8ME21AFSAA	VFD4A2ME43AFSAA	
VFD4A2ME43ANNAA		VFD1A6ME21AFNAA		
VFD4A2ME43ANSAA		VFD1A6ME21AFSAA		
		VFD2A8ME21AFNAA		
		VFD2A8ME21AFSAA		
		VFD4A8ME21AFNAA		
		VFD4A8ME21AFSAA		
		VFD1A5ME43AFNAA		
		VFD1A5ME43AFSAA		
		VFD2A7ME43AFNAA		
		VFD2A7ME43AFSAA		

Frame		W	H	D	W1	H1	D1	S1
B1	mm	72.0	142.0	127.0	60.0	130.0	6.4	5.2
	inch	2.83	5.59	5.00	2.36	5.12	0.25	0.20
Frame		W	H	D	W1	H1	D1	S1
B2	mm	72.0	142.0	127.0	60.0	130.0	3.0	5.2
	inch	2.83	5.59	5.00	2.36	5.12	0.12	0.20
Frame		W	H	D	W1	H1	D1	S1
B3	mm	72.0	142.0	143.0	60.0	130.0	4.3	5.2
	inch	2.83	5.59	5.63	2.36	5.12	0.17	0.20

Specifications

Dimensions

Frame C

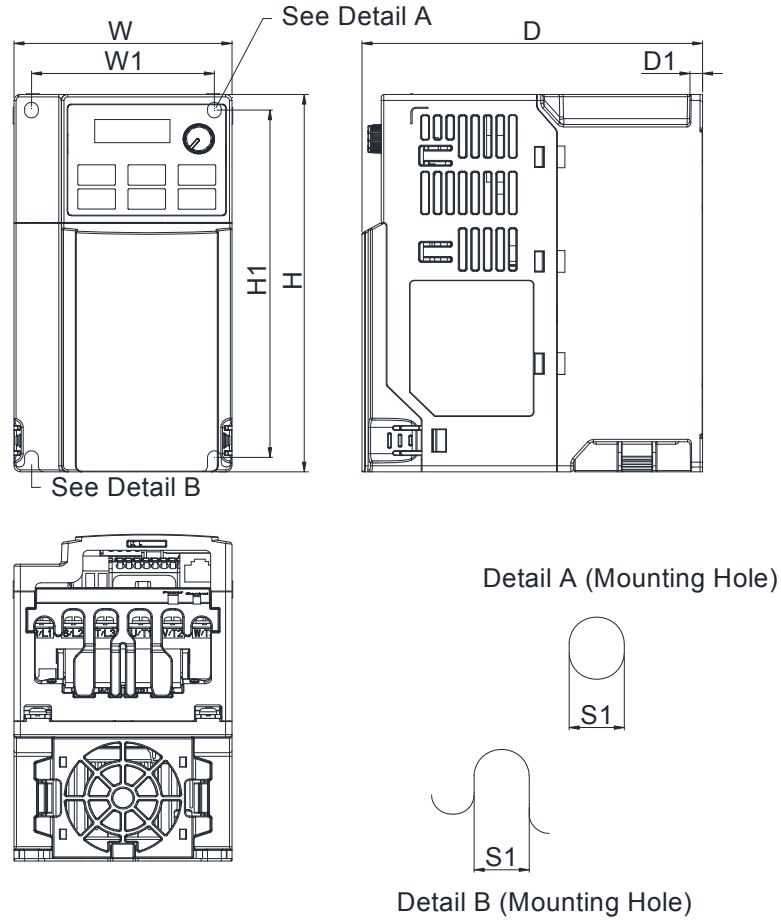

Model		Frame C1		Frame C2	
VFD4A8ME11ANNAA	VFD9A0ME43ANNAA	VFD7A5ME21AFNAA			
VFD4A8ME11ANSAA	VFD9A0ME43ANSAA	VFD7A5ME21AFSAA			
VFD7A5ME21ANNAA		VFD11AME21AFNAA			
VFD7A5ME21ANSAA		VFD11AME21AFSAA			
VFD11AME21ANNAA		VFD5A5ME43AFNAA			
VFD11AME21ANSAA		VFD5A5ME43AFSAA			
VFD11AME23ANNAA		VFD7A3ME43AFNAA			
VFD11AME23ANSAA		VFD7A3ME43AFSAA			
VFD17AME23ANNAA		VFD9A0ME43AFNAA			
VFD17AME23ANSAA		VFD9A0ME43AFSAA			
VFD5A5ME43ANNAA					
VFD5A5ME43ANSAA					
VFD7A3ME43ANNAA					
VFD7A3ME43ANSAA					

Frame		W	H	D	W1	H1	D1	S1
C1	mm	87.0	157.0	136.0	73.0	144.5	5.0	5.5
	inch	3.43	6.18	5.35	2.87	5.69	0.20	0.22
Frame		W	H	D	W1	H1	D1	S1
C2	mm	87.0	157.0	163.0	73.0	144.5	5.0	5.5
	inch	3.43	6.18	6.42	2.87	5.69	0.20	0.22

Frame D

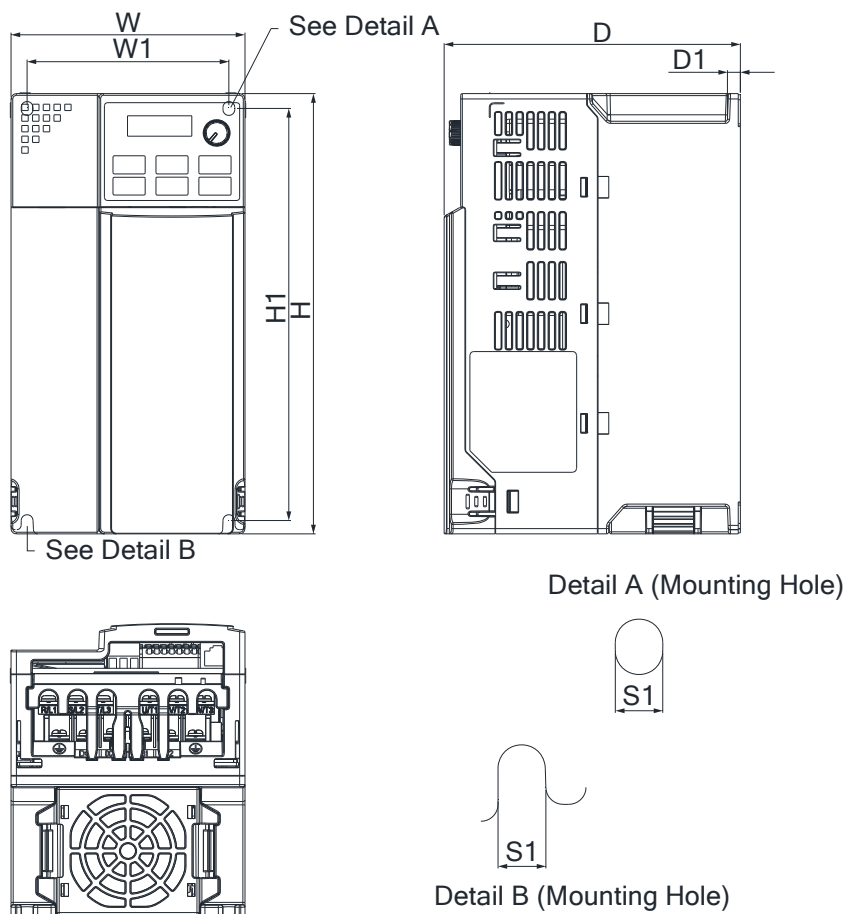

Model

Frame D1

VFD25AME23ANNAA
 VFD25AME23ANSAA
 VFD13AME43ANNAA
 VFD13AME43ANSAA
 VFD17AME43ANNAA
 VFD17AME43ANSAA

Frame D2

VFD13AME43AFNAA
 VFD13AME43AFSAA
 VFD17AME43AFNAA
 VFD17AME43AFSAA

Frame		W	H	D	W1	H1	D1	S1
D1	mm	109.0	207.0	138.0	94.0	193.8	6.0	5.5
	inch	4.29	8.15	5.43	3.70	7.63	0.24	0.22
Frame		W	H	D	W1	H1	D1	S1
D2	mm	109.0	207.0	171.0	94.0	193.8	6.0	5.5
	inch	4.29	8.15	6.73	3.70	7.63	0.24	0.22

Specifications

Accessories

- RJ45 Extension Cable for Digital Keypad



Title	Part No.	L	
		mm	inch
1	UC-CMC003-01A	300	11.8
2	UC-CMC005-01A	500	19.6
3	UC-CMC010-01A	1000	39
4	UC-CMC015-01A	1500	59
5	UC-CMC020-01A	2000	78.7
6	UC-CMC030-01A	3000	118.1
7	UC-CMC050-01A	5000	196.8
8	UC-CMC100-01A	10000	393.7
9	UC-CMC200-01A	20000	787.4

- Accessory for Multi-pump Applications

MKCB-HUB01

- RJ45 sockets x3

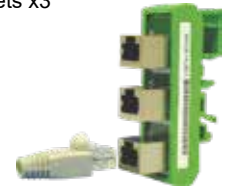

- Digital Keypads



KPC-CC01

- Highly illuminated LCD display
- Displays multiple information simultaneously



KPC-CE01

- RJ45 Port
- 5-digit LED display
- Large key press for easy on-site setup



PU-08

- RJ45 Port
- 4-digit LED display
- Compact design for easy installation

Model Name

VFD 1A5 ME 43 A N N A A

Variable Frequency Drive

Rated Output Current
Under Heavy Duty Mode (150% 60 seconds)

Series Name
ME : Basic Compact Drive ME300

Input Voltage
11 : 115V single-phase 23 : 230V three-phase
21 : 230V single-phase 43 : 460V three-phase

IP Level
A : IP20

Version

Model Type
A : Standard model

Safe Torque Off (STO)
N : None
S : STO Model

EMC Filter
N : None
F : Built-in EMC Filter

Ordering Information

Power Range			Frame Size	Model Name	Standard Models (0 ~ 599 Hz)	
Max. Applicable Motor Capacity		Drive Rated Output Current			Built-in EMC Filter	Built-in STO
[HP]	[kW]	[A]				
115V/single-phase						
1/8	0.1	0.8	A	VFD0A8ME11ANNAA		
1/8	0.1	0.8	A	VFD0A8ME11ANSAA		V
1/4	0.2	1.6	A	VFD1A6ME11ANNAA		
1/4	0.2	1.6	A	VFD1A6ME11ANSAA		V
1/2	0.4	2.5	A	VFD2A5ME11ANNAA		
1/2	0.4	2.5	A	VFD2A5ME11ANSAA		V
1	0.75	4.8	C	VFD4A8ME11ANNAA		
1	0.75	4.8	C	VFD4A8ME11ANSAA		V
230V/single-phase						
1/8	0.1	0.8	A	VFD0A8ME21ANNAA		
1/8	0.1	0.8	A	VFD0A8ME21ANSAA		V
1/8	0.1	0.8	B	VFD0A8ME21AFNAA	V	
1/8	0.1	0.8	B	VFD0A8ME21AFSAA	V	V
1/4	0.2	1.6	A	VFD1A6ME21ANNAA		
1/4	0.2	1.6	A	VFD1A6ME21ANSAA		V
1/4	0.2	1.6	B	VFD1A6ME21AFNAA	V	
1/4	0.2	1.6	B	VFD1A6ME21AFSAA	V	V
1/2	0.4	2.8	A	VFD2A8ME21ANNAA		
1/2	0.4	2.8	A	VFD2A8ME21ANSAA		V
1/2	0.4	2.8	B	VFD2A8ME21AFNAA	V	
1/2	0.4	2.8	B	VFD2A8ME21AFSAA	V	V
1	0.75	4.8	B	VFD4A8ME21ANNAA		
1	0.75	4.8	B	VFD4A8ME21ANSAA		V
1	0.75	4.8	B	VFD4A8ME21AFNAA	V	
1	0.75	4.8	B	VFD4A8ME21AFSAA	V	V
2	1.5	7.5	C	VFD7A5ME21ANNAA		
2	1.5	7.5	C	VFD7A5ME21ANSAA		V
2	1.5	7.5	C	VFD7A5ME21AFNAA	V	
2	1.5	7.5	C	VFD7A5ME21AFSAA	V	V
3	2.2	11.0	C	VFD11AME21ANNAA		
3	2.2	11.0	C	VFD11AME21ANSAA		V
3	2.2	11.0	C	VFD11AME21AFNAA	V	
3	2.2	11.0	C	VFD11AME21AFSAA	V	V
230V/three-phase						
1/8	0.1	0.8	A	VFD0A8ME23ANNAA		
1/8	0.1	0.8	A	VFD0A8ME23ANSAA		V
1/4	0.2	1.6	A	VFD1A6ME23ANNAA		
1/4	0.2	1.6	A	VFD1A6ME23ANSAA		V
1/2	0.4	2.8	A	VFD2A8ME23ANNAA		
1/2	0.4	2.8	A	VFD2A8ME23ANSAA		V
1	0.75	4.8	A	VFD4A8ME23ANNAA		

Specifications

Ordering Information

Power Range			Frame Size	Model Name	Standard Models (0 ~ 599 Hz)	
Max. Applicable Motor Capacity		Drive Rated Output Current			Built-in EMC Filter	Built-in STO
[HP]	[kW]	[A]				
230 V / three-phase						
1	0.75	4.8	A	VFD4A8ME23ANSAA		V
2	1.5	7.5	B	VFD7A5ME23ANNAA		
2	1.5	7.5	B	VFD7A5ME23ANSAA		V
3	2.2	11.0	C	VFD11AME23ANNAA		
3	2.2	11.0	C	VFD11AME23ANSAA		V
5	3.7/4	17.0	C	VFD17AME23ANNAA		
5	3.7/4	17.0	C	VFD17AME23ANSAA		V
7.5	5.5	25.0	D	VFD25AME23ANNAA		
7.5	5.5	25.0	D	VFD25AME23ANSAA		V
460 V / three-phase						
1/2	0.4	1.5	A	VFD1A5ME43ANNAA		
1/2	0.4	1.5	A	VFD1A5ME43ANSAA		V
1/2	0.4	1.5	B	VFD1A5ME43AFNAA	V	
1/2	0.4	1.5	B	VFD1A5ME43AFSAA	V	V
1	0.75	2.7	A	VFD2A7ME43ANNAA		
1	0.75	2.7	A	VFD2A7ME43ANSAA		V
1	0.75	2.7	B	VFD2A7ME43AFNAA	V	
1	0.75	2.7	B	VFD2A7ME43AFSAA	V	V
2	1.5	4.2	B	VFD4A2ME43ANNAA		
2	1.5	4.2	B	VFD4A2ME43ANSAA		V
2	1.5	4.2	B	VFD4A2ME43AFNAA	V	
2	1.5	4.2	B	VFD4A2ME43AFSAA	V	V
3	2.2	5.5	C	VFD5A5ME43ANNAA		
3	2.2	5.5	C	VFD5A5ME43ANSAA		V
3	2.2	5.5	C	VFD5A5ME43AFNAA	V	
3	2.2	5.5	C	VFD5A5ME43AFSAA	V	V
4	3	7.3	C	VFD7A3ME43ANNAA		
4	3	7.3	C	VFD7A3ME43ANSAA		V
4	3	7.3	C	VFD7A3ME43AFNAA	V	
4	3	7.3	C	VFD7A3ME43AFSAA	V	V
5	3.7/4	9.0	C	VFD9A0ME43ANNAA		
5	3.7/4	9.0	C	VFD9A0ME43ANSAA		V
5	3.7/4	9.0	C	VFD9A0ME43AFNAA	V	
5	3.7/4	9.0	C	VFD9A0ME43AFSAA	V	V
7.5	5.5	13.0	D	VFD13AME43ANNAA		
7.5	5.5	13.0	D	VFD13AME43ANSAA		V
7.5	5.5	13.0	D	VFD13AME43AFNAA	V	
7.5	5.5	13.0	D	VFD13AME43AFSAA	V	V
10	7.5	17.0	D	VFD17AME43ANNAA		
10	7.5	17.0	D	VFD17AME43ANSAA		V
10	7.5	17.0	D	VFD17AME43AFNAA	V	
10	7.5	17.0	D	VFD17AME43AFSAA	V	V



Smarter. Greener. Together.

Industrial Automation Headquarters

Taiwan: Delta Electronics, Inc.

Taoyuan Technology Center
No.18, Xinglong Rd., Taoyuan District,
Taoyuan City 33068, Taiwan
TEL: +886-3-362-6301 / FAX: +886-3-371-6301

Asia

China: Delta Electronics (Shanghai) Co., Ltd.

No.182 Minyu Rd., Pudong Shanghai, P.R.C.
Post code : 201209
TEL: +86-21-6872-3988 / FAX: +86-21-6872-3996
Customer Service: 400-820-9595

Japan: Delta Electronics (Japan), Inc.

Industrial Automation Sales Department
2-1-14 Shibadaimon, Minato-ku
Tokyo, Japan 105-0012
TEL: +81-3-5733-1155 / FAX: +81-3-5733-1255

Korea: Delta Electronics (Korea), Inc.

1511, 219, Gasan Digital 1-Ro., Geumcheon-gu,
Seoul, 08501 South Korea
TEL: +82-2-515-5305 / FAX: +82-2-515-5302

Singapore: Delta Energy Systems (Singapore) Pte Ltd.

4 Kaki Bukit Avenue 1, #05-04, Singapore 417939
TEL: +65-6747-5155 / FAX: +65-6744-9228

India: Delta Electronics (India) Pvt. Ltd.

Plot No.43, Sector 35, HSIIDC Gurgaon,
PIN 122001, Haryana, India
TEL: +91-124-4874900 / FAX: +91-124-4874945

Thailand: Delta Electronics (Thailand) PCL.

909 Soi 9, Moo 4, Bangpoo Industrial Estate (E.P.Z),
Pattana 1 Rd., T.Phraksa, A.Muang,
Samutprakarn 10280, Thailand
TEL: +66-2709-2800 / FAX: +66-2709-2827

Australia: Delta Electronics (Australia) Pty Ltd.

Unit 20-21/45 Normanby Rd., Notting Hill Vic 3168, Australia
TEL: +61-3-9543-3720

Americas

USA: Delta Electronics (Americas) Ltd.

5101 Davis Drive, Research Triangle Park, NC 27709, U.S.A.
TEL: +1-919-767-3813 / FAX: +1-919-767-3969

Brazil: Delta Electronics Brazil

Rua Itapeva, 26 - 3º, andar Edifício Itapeva,
One - Bela Vista 01332-000 - São Paulo - SP - Brazil
TEL: +55-12-3932-2300 / FAX: +55-12-3932-237

Mexico: Delta Electronics International Mexico S.A. de C.V.

Gustavo Baz No. 309 Edificio E PB 103
Colonia La Loma, CP 54060
Tlalnepantla, Estado de México
TEL: +52-55-3603-9200

EMEA

EMEA Headquarters: Delta Electronics (Netherlands) B.V.

Sales: Sales.IA.EMEA@deltaww.com
Marketing: Marketing.IA.EMEA@deltaww.com
Technical Support: iatechnicalsupport@deltaww.com
Customer Support: Customer-Support@deltaww.com
Service: Service.IA.emea@deltaww.com
TEL: +31(0)40 800 3900

BENELUX: Delta Electronics (Netherlands) B.V.

Automotive Campus 260, 5708 JZ Helmond, The Netherlands
Mail: Sales.IA.Benelux@deltaww.com
TEL: +31(0)40 800 3900

DACH: Delta Electronics (Netherlands) B.V.

Coesterweg 45, D-59494 Soest, Germany
Mail: Sales.IA.DACH@deltaww.com
TEL: +49(0)2921 987 0

France: Delta Electronics (France) S.A.

ZI du bois Challand 2, 15 rue des Pyrénées,
Lisses, 91090 Evry Cedex, France
Mail: Sales.IA.FR@deltaww.com
TEL: +33(0)1 69 77 82 60

Iberia: Delta Electronics Solutions (Spain) S.L.U

Ctra. De Villaverde a Vallecas, 265 1º Dcha Ed.
Hormigueras – P.I. de Vallecas 28031 Madrid
TEL: +34(0)91 223 74 20

Carrer Llacuna 166, 08018 Barcelona, Spain

Mail: Sales.IA.Iberia@deltaww.com

Italy: Delta Electronics (Italy) S.r.l.

Via Meda 2-22060 Novedrate(CO)
Piazza Grazioli 18 00186 Roma Italy
Mail: Sales.IA.Italy@deltaww.com
TEL: +39 039 8900365

Russia: Delta Energy System LLC

Vereyskaya Plaza II, office 112 Vereyskaya str.
17 121357 Moscow Russia
Mail: Sales.IA.RU@deltaww.com
TEL: +7 495 644 3240

Turkey: Delta Greentech Elektronik San. Ltd. Sti. (Turkey)

Şerifali Mah. Hendem Cad. Kule Sok. No:16-A
34775 Ümraniye – İstanbul
Mail: Sales.IA.Turkey@deltaww.com
TEL: + 90 216 499 9910

MEA: Eltek Dubai (Eltek MEA DMCC)

OFFICE 2504, 25th Floor, Saba Tower 1,
Jumeirah Lakes Towers, Dubai, UAE
Mail: Sales.IA.MEA@deltaww.com
TEL: +971(0)4 2690148